

**B-CONTROL ▶ FADER BCF2000**      **B-CONTROL ▶ ROTARY BCR2000**

# User's Manual

Version 1.0 November 2003

ENGLISH



[www.behringer.com](http://www.behringer.com)



**IMPORTANT SAFETY INSTRUCTIONS**



**CAUTION:** To reduce the risk of electric shock, do not remove the top cover (or the rear section). No user serviceable parts inside; refer servicing to qualified personnel.

**WARNING:** To reduce the risk of fire or electric shock, do not expose this appliance to rain and moisture.



This symbol, wherever it appears, alerts you to the presence of uninsulated dangerous voltage inside the enclosure—voltage that may be sufficient to constitute a risk of shock.



This symbol, wherever it appears, alerts you to important operating and maintenance instructions in the accompanying literature. Please read the manual.

**DETAILED SAFETY INSTRUCTIONS:**

- 1) Read these instructions.
  - 2) Keep these instructions.
  - 3) Heed all warnings.
  - 4) Follow all instructions.
  - 5) Do not use this device near water.
  - 6) Clean only with a dry cloth.
  - 7) Do not block any ventilation openings. Install in accordance with the manufacturer's instructions.
  - 8) Do not install near any heat sources such as radiators, heat registers, stoves, or other apparatus (including amplifiers) that produce heat.
  - 9) Do not defeat the safety purpose of the polarized or grounding-type plug. A polarized plug has two blades with one wider than the other. A grounding type plug has two blades and a third grounding prong. The wide blade or the third prong are provided for your safety. If the provided plug does not fit into your outlet, consult an electrician for replacement of the obsolete outlet.
  - 10) Protect the power cord from being walked on or pinched particularly at plugs, extension cords, and the point at which they exit the unit.
  - 11) Only use attachments/accessories specified by the manufacturer.
  - 12) Use only with the cart, stand, tripod, bracket, or table specified by the manufacturer, or sold with the device. When a cart is used, use caution when moving the cart/device combination to avoid injury from stumbling over it.
- 
- 13) Unplug this device during lightning storms or when not used for long periods of time.
  - 14) Refer all servicing to qualified service personnel. Servicing is required when the unit has been damaged in any way, such as power supply cord or plug is damaged, liquid has been spilled or objects have fallen into the device, the unit has been exposed to rain or moisture, does not operate normally, or has been dropped.

**FOREWORD**



Dear Customer,

welcome to the team of BEHRINGER users, and thank you very much for expressing your confidence in us by purchasing the B-CONTROL.

Writing this foreword for you gives me great pleasure, because it represents the culmination of many months of hard work delivered by our engineering team to achieve a very ambitious goal: to present two outstanding USB MIDI CONTROLLERS. Due to their extreme flexibility they can be used as a

central control unit with USB/MIDI interface as well as for mere MIDI control applications. The task of designing our new B-CONTROLS certainly meant a great deal of responsibility, which we assumed by focusing on you, the discerning user and musician. Meeting your expectations also meant a lot of work and night shifts. But it was fun, too. Developing a product usually brings a lot of people together, and what a great feeling it is when all who participated in such a project can be proud of what they've achieved.

It is our philosophy to share our enjoyment with you, because you are the most important member of the BEHRINGER team. With your highly competent suggestions for new products you've made a significant contribution to shaping our company and making it successful. In return, we guarantee you uncompromising quality as well as excellent technical and audio properties at an extremely reasonable price. All of this will enable you to give free rein to your creativity without being hampered by budget constraints.

We are often asked how we manage to produce such high-quality devices at such unbelievably low prices. The answer is quite simple: it's you, our customers! Many satisfied customers mean large sales volumes enabling us to get better purchasing terms for components, etc. Isn't it only fair to pass this benefit on to you? Because we know that your success is our success too!

I would like to thank all of you who have made the B-CONTROL possible. You have all made your own personal contributions, from the developers to the many other employees at this company, and to you, the BEHRINGER user.

My friends, it's been worth the effort!

Thank you very much,

Uli Behringer

**TABLE OF CONTENTS**

**1. INTRODUCTION ..... 4**

- 1.1 Before you get started ..... 4
  - 1.1.1 Shipment ..... 4
  - 1.1.2 Initial operation ..... 4
  - 1.1.3 Warranty ..... 4
- 1.2 System requirements ..... 4

**2. INTRODUCTION TO MIDI ..... 4**

- 2.1 MIDI control for beginners ..... 4
- 2.2 The MIDI standard ..... 5
- 2.3 MIDI connections ..... 5
- 2.4 The MIDI format ..... 5

**3. CONTROL ELEMENTS AND CONNECTIONS ..... 6**

**4. CONTROLS ..... 8**

- 4.1 The operating modes ..... 8
  - 4.1.1 USB modes ..... 8
  - 4.1.2 Stand-alone modes ..... 10
- 4.2 "Play" mode menu ..... 12
  - 4.2.1 Selecting a preset ..... 12
  - 4.2.2 Copy/store presets ..... 13
  - 4.2.3 Copying encoder groups ..... 13
- 4.3 Programming ..... 13
  - 4.3.1 The LEARN function ..... 13
  - 4.3.2 Programming in EDIT mode ..... 13
  - 4.3.3 Settings in the global setup menu ..... 16
  - 4.3.4 Additional functions ..... 16

**5. APPENDIX ..... 17**

**6. SPECIFICATIONS ..... 18**

**7. WARRANTY ..... 19**

## 1. INTRODUCTION

Thank you very much for expressing your confidence in BEHRINGER products by purchasing the B-CONTROL.

The B-CONTROL is an extremely flexible control surface suitable for a wide array of applications. Regardless of whether you want to intuitively control your sequencer software with mixers, plug-ins and virtual instruments, or if you wish to use its broad MIDI functions for controlling rack synthesizers, general MIDI sound generators or effect processors, the B-CONTROL offers you tremendous ease of use that leaves no wishes open.

To ensure the highest possible operating safety, our equipment is manufactured according to the highest quality standards in the audio industry. Additionally, we produce our equipment adhering to the ISO9000 certified management system.

 **The following user's manual is intended to familiarize you with the unit's control elements, so that you can master all the functions. After having thoroughly read the user's manual, store it at a safe place for future reference.**

### 1.1 Before you get started

#### 1.1.1 Shipment

The B-CONTROL was carefully packed at the assembly plant to assure secure transport. Should the condition of the cardboard box suggest that damage may have taken place, please inspect the unit immediately and look for physical indications of damage.

 **Damaged equipment should NEVER be sent directly to us. Please inform the dealer from whom you acquired the unit immediately as well as the transportation company from which you took delivery of the unit. Otherwise, all claims for replacement/repair may be rendered invalid.**

 **To assure optimal protection of your B-CONTROL during use or transport, we recommend utilizing a carrying case.**

 **Please always use the original packaging to avoid damage due to storage or shipping.**

 **Never let unsupervised children play with the B-CONTROL or with its packaging.**

 **Please dispose of all packaging materials in an environmentally-friendly fashion.**

#### 1.1.2 Initial operation

Please make sure the unit is provided with sufficient ventilation, and never place the B-CONTROL on top of an amplifier or in the vicinity of a heater to avoid the risk of overheating.

A power supply unit which meets the necessary safety requirements is enclosed for connecting the B-CONTROL to the mains.

#### 1.1.3 Warranty

Please take a few minutes and send us the completely filled out warranty card within 14 days of the date of purchase to assure unproblematic warranty processing in the future. You may also register online at [www.behringer.com](http://www.behringer.com). The serial number needed for the registration is located at the top of the unit. Failure to register your product may void future warranty claims.

## 1.2 System requirements

for USB operation:

Up-to-date WINDOWS® PC or MAC® with a USB connection

 **The B-CONTROL supports WINDOWS® XP and MAC OS X® "USB MIDI compatibility". Soon, you will be able to download drivers for other operating systems, for multi unit support, new presets as well as a WINDOWS editor software free of charge. Just click [www.behringer.com](http://www.behringer.com) to get it for free.**

 **The BCF2000/BCR2000 can also be operated stand-alone without a PC as a pure MIDI controller. Software control via MIDI is also possible, provided your computer has a MIDI interface.**

## 2. INTRODUCTION TO MIDI

### 2.1 MIDI control for beginners

Application possibilities for both B-CONTROL models, the BCF2000 and the BCR2000, are truly wide-ranging. We'll start with a couple of general explanations and examples that should quickly let you get a good understanding of MIDI basics.

**What exactly does the B-CONTROL do?**

Simply put, this is a remote control for all kinds of MIDI equipment. Using the faders (BCF2000 only), encoders (infinitely variable rotary controls) and keys, an entire array of control functions can be performed. Adjusting these parameters, you can control various functions of external (hardware or software) equipment in real time. For example, countless software mixers, sound generators or effects can be remotely controlled. With these software applications, you are dealing with simulations of "real" equipment in your computer, whereby they are visually represented on the computer screen, while the computer takes over the function of replicating their respective functions.

**And how does it work?**

You can assign particular MIDI data to each control element on the B-CONTROL; for example, you can assign the so-called "MIDI-Controller 7" (CC 07) that adjusts the volume of a MIDI device to one of the controls on your BCF2000/BCR2000. If you move/turn the corresponding control on your B-CONTROL, you can hear how the volume on the receiving MIDI device also changes (provided it is also connected to an audio output). Keep the following in mind:

 **MIDI data is only control data and contains no audio information!**

**What settings do I have to make? Where? How?**

Often, you can assign MIDI control data numbers, the so-called control change or CC numbers, to individual MIDI parameters. That's particularly the case with music software such as software sequencers, mixers and sound generators as well as the so-called "plug-ins" (effect units or sound generators integrated into the software).

**Basically, you have 2 options:**

You either set the desired control numbers at the B-CONTROL and transmit them to the software you are controlling, or you can set the desired control data directly on your MIDI device and let the B-CONTROL receive the information about number assignment using the LEARN procedure.

**Example:**

On a software synthesizer, you want to control filter frequency, filter resonance and volume using the MIDI controllers 5, 6 and 7.

To receive MIDI data, you'll need to perform the following settings on your software synthesizer:



- ▲ set filter frequency to CC 05
- ▲ set filter resonance to CC 06 (receive)
- ▲ set volume to CC 07 (receive)

To get detailed information on how to assign them, please refer to chapter 4.3.2 "Programming in the EDIT mode" on page 13.

Now, define in the B-CONTROL the control elements that will control these 3 parameters. You can either use the LEARN function if the software synthesizer gives you the option to send its CC data via MIDI, or you can implement the following settings manually:

- ▲ Assign the push encoder 1 CC 05 to filter frequency control via dial rotation.
- ▲ Assign the push encoder 2 CC 06 to filter resonance control via dial rotation.
- ▲ Assign the push encoder 3 CC 07 to volume control via dial rotation.

**How do I wire the B-CONTROL?**

Several classic examples can be found in the explanations of different operating modes (see chapter 4.1 "The Operating Modes"). Basically, the following applies:

- ▲ If you want to control hardware MIDI equipment, use the MIDI connectors.
- ▲ To control software MIDI equipment, you can either use the MIDI connectors on your B-CONTROL – provided your computer has a MIDI interface – or you can use a USB connection.
- ▲ To remotely control both hardware and software equipment, several combination modes are available. These are explained in chapter 4.1.

**What kinds of equipment can I control with the B-CONTROL?**

You can basically control any device supporting the MIDI format. Both hardware and software MIDI devices are controlled exactly the same. The only difference is in the wiring.

**Here are a couple of suggestions on how you can use your B-CONTROL:**

- ▲ Editing sound parameters of (virtual) synthesizers, sound samplers, GM/GS/XG sound generators
- ▲ Controlling parameters on effects equipment/software plug-ins such as effects processors, reverbs, compressors, equalizers etc.
- ▲ Remotely controlling software mixers (volume, panorama, equalizers etc.)
- ▲ Remotely controlling transport functions (playback, forward, stop etc.) on sequencers, hard disk recorders, drum computers etc.
- ▲ Using BCF2000 faders as drawbar control for virtual or digital organ expanders
- ▲ Controlling MIDI-enabled lighting equipment
- ▲ Live control of volume and sound parameters on expanders
- ▲ Triggering (i.e. playing live) short samples, drum loops, shouts, effects etc.
- ▲ Remotely controlling groove boxes, step sequencers, MIDI generators (such as arpeggiators etc.), DJ software and other "live" software
- ▲ Program changes and volume control on sound generators (just like on a master keyboard)
- ▲ Likewise, applicable to band keyboardists, solo entertainers, organists, electronic music performers, DJs, sound engineers, home/project studio owners, theater technicians etc.

**2.2 The MIDI standard**

The MIDI standard (Musical Instruments Digital Interface) was developed in the early '80s to make communication between equipment from different manufacturers possible. Over the years, the MIDI interface has become hugely popular; it has become a matter of fact that complete studios can be connected via MIDI.

At the center of any such network is at least one computer that controls peripheral equipment. You can use the B-CONTROL in such a studio to control your sequencer or other software tools running on your computer (e.g. software mixers, VST instruments, effect plug-ins). But even if you don't use a computer, you can use the B-CONTROL as a central control surface in your studio for comfortably editing your rack synthesizers, GM/GS/XG sound generators and effects equipment.

**2.3 MIDI connections**

The MIDI connections in the back of your B-CONTROL feature the standard 5-pin DIN connectors. You will require MIDI cables to connect your B-CONTROL to other MIDI equipment. In general, commercially available ready-to-use cables can and should be used. Their length should not exceed 15 m (50 ft.).

*MIDI IN:* Used for receiving MIDI data (parameter feedback, SysEx data), or to mix MIDI signals with the B-CONTROL signals (merge function).

*MIDI OUT A/B:* Data for controlling other MIDI equipment can be sent through the MIDI outputs.

 **The B-CONTROL has two MIDI outputs. MIDI OUT B can be configured as MIDI THRU, so that the incoming data at MIDI IN can be passed through unaffected.**

**2.4 The MIDI format**

Although your B-CONTROL is very easy to use, it still makes sense to review some information about this data format. Each MIDI command, also called message, consists of a status byte and up to two data bytes. The status byte defines the command type, and the data bytes contain the corresponding values. Different types of MIDI messages used by the B-CONTROL are explained next:

**Note messages:**

Among keyboard hotshots, Note On and Note Off messages are among the essential MIDI messages. Playing MIDI instruments from a master keyboard or computer is only possible with these messages. The B-CONTROL can also send Note Messages; however, this is not absolutely necessary to play music. This way, note events are also used to trigger drumloops or individual notes from a sampler. Many effects processors also allow rhythmic entering of delay times or song tempos with note commands.

Note On and Note Off messages have the following data format:

	Status Byte	Data Byte 1	Data Byte 2
Note Off	&8n (n = channel #)	Note #	Velocity
Note On	&9n (n = channel #)	Note #	Velocity

*Table 2.1: Data format of Note On and Note Off messages*

The value range for channel numbers is between 1 and 16; for data bytes it is 0 to 127. Even though Note Off messages are not really used by keyboarders anymore, the B-CONTROLS support sending this status information.

Velocity corresponds to the key pressure, and therefore to the volume of a touch-sensitive keyboard (piano). Since the B-CONTROL does not feature touch-sensitive keys, the velocity value is transmitted with a fixed value that can be set during programming.

 **A note command can only be assigned to keys, footswitches and push functions of the encoder.**

**Control Change (CC):**

Control Change Messages are some of the most “powerful” MIDI messages. Using them, a vast number of parameters and functions can be recalled and automated. Individual control elements (faders, rotary dials, keys etc.) can be assigned to CC messages on your B-CONTROL. Because not only keys but also faders and rotary dials can be used, control values can be controlled in real time either statically or dynamically. A list with the standard controller numbers can be found in this user manual’s appendix.

**NRPN:**

Additionally, controllers that have no standardized assignment can also be used, and can therefore be assigned according to no predetermined rule. These controllers are called NRPNs (Non-Registered Parameter Numbers). NRPNs are further subdivided into MSB (Most Significant Byte) and LSB (Least Significant Byte) in order to achieve a higher resolution. A lower resolution is particularly easy to observe during fader movement of a mixer, in which 7-bit (= 128 values) jumps in the signal level can be heard. By subdividing NRPNs into MSB and LSB, you can achieve 14-bit resolution of faders and rotary dials, which means that the movement of a fader is divided into more than 16,000 steps (2<sup>14</sup>)! In addition to NRPNs, there are also RPNs (Registered Parameter Numbers). RPN commands are defined as GM (general MIDI), GS (Roland) and XG (Yamaha) MIDI standards.

**Pitch Bend**

The pitch-bend wheel of a keyboard is used for tone modulation and has its own commands in the MIDI format.

**After Touch**

MIDI keyboards featuring After Touch can respond to varying key pressure even after you release the key (i.e. after the keystroke is over) and can send this data via MIDI. This function either reacts key-specific (key pressure) or it reacts to all notes at the same time (channel pressure).

**MIDI Machine Control (MMC):**

With MIDI Machine Control, you can assign transport functions of a sequencer or drum computer (e.g. start, stop, FFW/RWD) and locator points to individual keys with a permanently adjustable time position (locate, punch in/out points).

**Program Change Messages and MIDI Bank Select:**

Program change messages are used to recall programs/presets in MIDI devices connected to your B-CONTROL. 128 program numbers can be recalled. For devices with more than 128 presets, use the bank select function, which lets you select a storage bank before sending a program change.

**Running Status:**

Because the MIDI interface is a serial data transmission format (meaning that its data is transmitted as a succession of individual data segments), it became apparent very quickly that it may not be fast enough. To avoid perceptible delays in the output of MIDI data, Running Status was designed. It suppresses the transmission of the status byte when the same MIDI messages are transmitted in succession. This means that, for example, during a continuous change of the data byte of a controller (e.g. volume), the status byte is only sent once. The only thing that is transmitted are the changes in the data byte. This goes on until another status byte is sent. 8 bits are saved for each message sent.

**SysEx Dump:**

System-Exclusive data refer to a function that makes transmission of nonspecific data via MIDI possible. This is often used for reading out memory contents and storing them externally.

The status byte notes the data type (SysEx); the first three data bytes are a manufacturer ID, so that when you have a large MIDI network, you can still “talk” to the correct MIDI device.

To make using several identical B-CONTROLS at the same time possible, you can assign a device number (device ID) in the global setup menu to each B-CONTROL, which assures that only the correct device receives the data intended for it.

**3. CONTROL ELEMENTS AND CONNECTIONS**

In this chapter, we will describe various control elements of your B-CONTROL. All controls and connectors are explained in detail, and we’ll give you useful tips on how to use them.

- 1 The 8 infinitely variable push encoders are used to send MIDI data. They have two functions (turn and press) that can be assigned to different MIDI commands.
- 2 Each of these 16 keys can send one MIDI command.
- 3 The four-digit LED display indicates the current operating software version briefly during startup. After that, it shows the selected preset number. When in play mode, activating one of the control elements indicates value changes on the LED in real time. When in programming mode, it indicates the type of MIDI commands, program/channel numbers and parameter values.
- 4 Using the ENCODER GROUP keys, four so-called encoder groups per preset can be recalled, so that eight PUSH encoders for a total of 64 different MIDI functions are at your disposal.
- 5 These LEDs indicate the following:  
*MIDI IN, OUT A* and *OUT B* illuminate if MIDI data flows through the respective connectors.  
*USB Mode* illuminates if a USB connection to a computer is active (your computer must be on).  
The *FOOT SW* LEDs illuminate if the footswitch is actuated.  
*FOOT CTRL* (BCF2000 only) illuminates when the footswitch pedal is pressed (MIDI data is sent).
- 6 Permanently fixed functions are assigned to this key section:  
*STORE* saves presets.  
*LEARN* gets you to the LEARN mode.  
*EDIT* gets you to the EDIT mode.  
Using the *EXIT* key, you exit a programming level (edit mode/global setup). Use it also to cancel a store or copy procedure.
- 7 The eight 100-mm faders of the BCF2000 are freely assignable for controlling MIDI commands. They are motorized, so they automatically slide into the predetermined position when you switch to another preset. If the software you are controlling or the MIDI device to which your B-CONTROL is connected support parameter feedback, the fader positions change automatically.
- 8 Using the *PRESET* keys, 32 presets can be recalled. The preset number is shown in the display.
- 9 These four keys can be assigned to any MIDI command of your choice.
- 10 The 24 infinitely variable rotary controls (encoders) of the BCR2000 can be programmed to send MIDI control commands. The LED circle show the current value.
- 11 These are the *SWITCH* connectors for connecting a footswitch. Its polarity is automatically detected. On the BCR2000, the first connector (*SWITCH 1*) can also be used to connect a double footswitch with stereo jacks. In this case, *SWITCH 2* must remain unused.

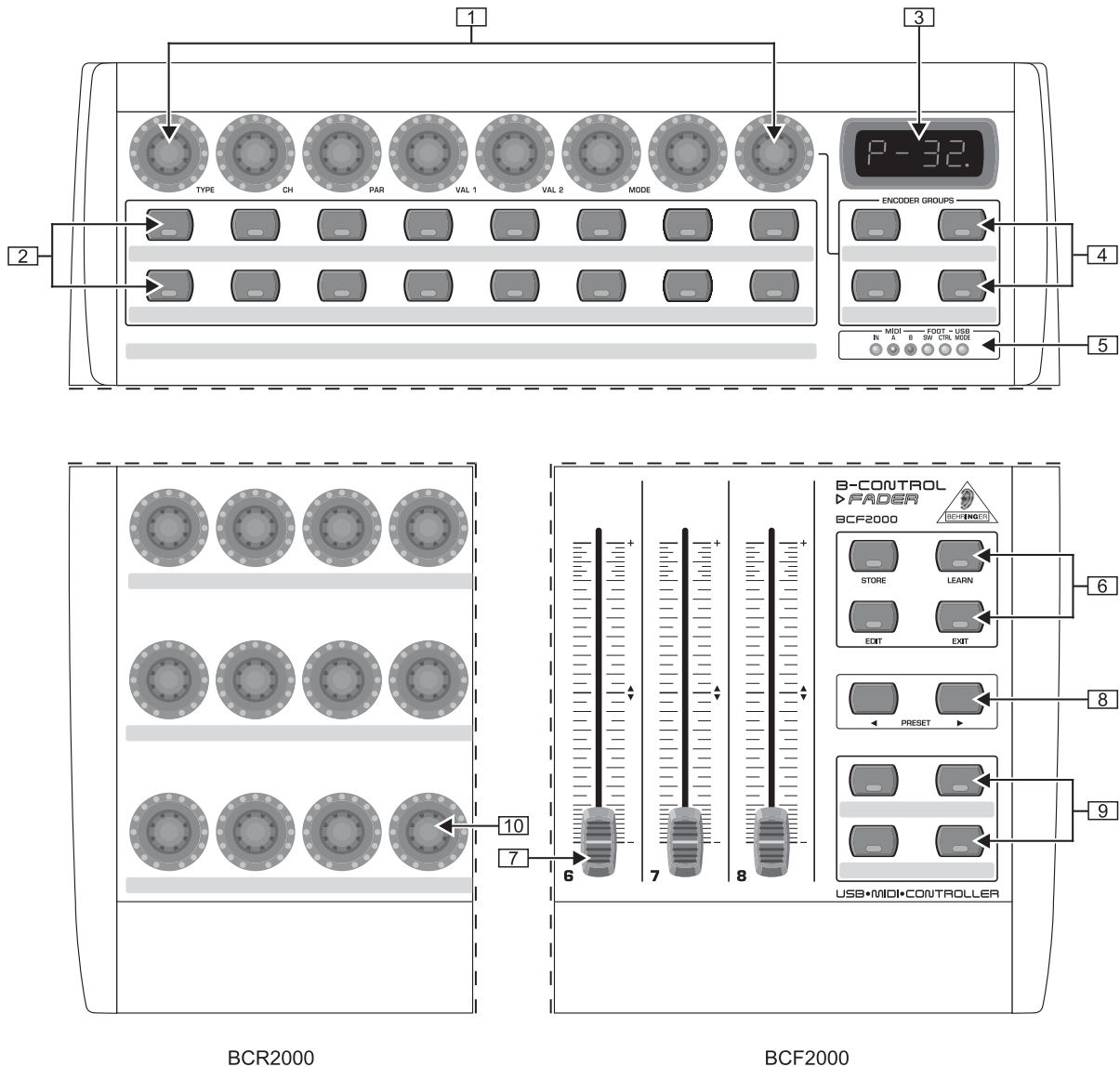

Fig. 3.1: The control surface of the B-CONTROLS

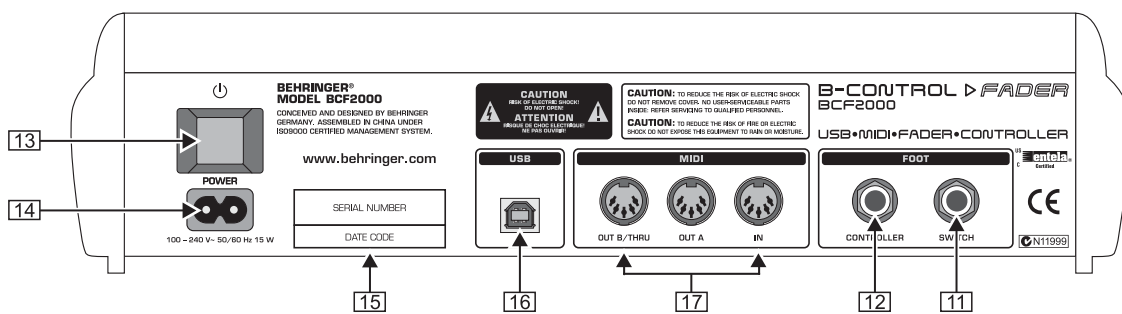

Fig.3.2: The back of the BCF2000 (control elements 13 to 17 coincide with the BCR2000)

- 12 CONTROLLER connector (BCF2000 only). Here, you can connect a footswitch that can be used for controlling assignable MIDI data.
- 13 The **POWER** switch turns your B-CONTROL on. The **POWER** switch should always be in its "Off" position when connecting the unit to the mains.
- 14 The connection to the mains is established using a standard connection socket. A matching cable is included in the shipment.
- 15 **SERIAL NUMBER**. Please take the time to fill out and return the warranty card within 14 days after the date of purchase to benefit from our extended warranty. The serial number is located on the top side of your REV2496. You can also register online at [www.behringer.com](http://www.behringer.com).

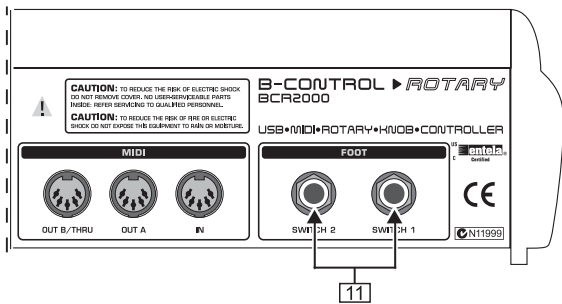

Fig. 3.3: The footswitch connectors on the BCR2000

- 16 The USB connector is used for connecting to a computer with a compatible USB input.
- 17 These are the MIDI connectors of your B-CONTROL. Depending on the operating mode, MIDI OUT B doubles as MIDI THRU.

## 4. CONTROLS

### 4.1 The operating modes

Depending on how you want to use your B-CONTROL, you should first select an operating mode.

You can use it as a pure USB controller for your computer applications (software mixers, sequencers, soft synths, VST-effects etc.), as a stand-alone MIDI controller, or as a combination of both with different MIDI interface configuration possibilities. Here is how you select an operating mode:

- ▲ Keep the EDIT key pressed, and press the STORE key at the same time.
- ▲ You are now in the global setup menu and you can let go of both keys.
- ▲ Now, select an operating mode by turning the PUSH encoder 1. You can select USB modes U-1 to U-4 and stand-alone modes S-1 to S-3. The modes are described in detail in chapter 4.1.1 and further, and examples about their use are also given there. Please see also chapter 4.3.3.
- ▲ To exit global setup, please press the EXIT key.
- 👉 **The settings made in the global setup menu are automatically stored and do not have to be separately saved.**

The USB connection is briefly interrupted if you switch within a USB mode, or when you switch from a USB mode to a stand-alone mode and vice versa.

If a USB connection is made or lost while your B-CONTROL is on, the selected operating mode is retained.

### 4.1.1 USB modes

#### USB mode U-1:

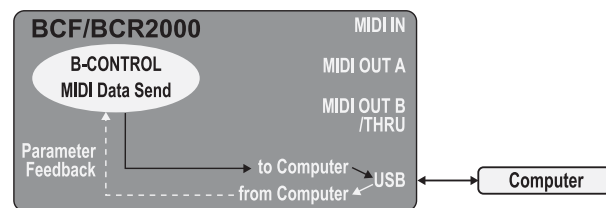
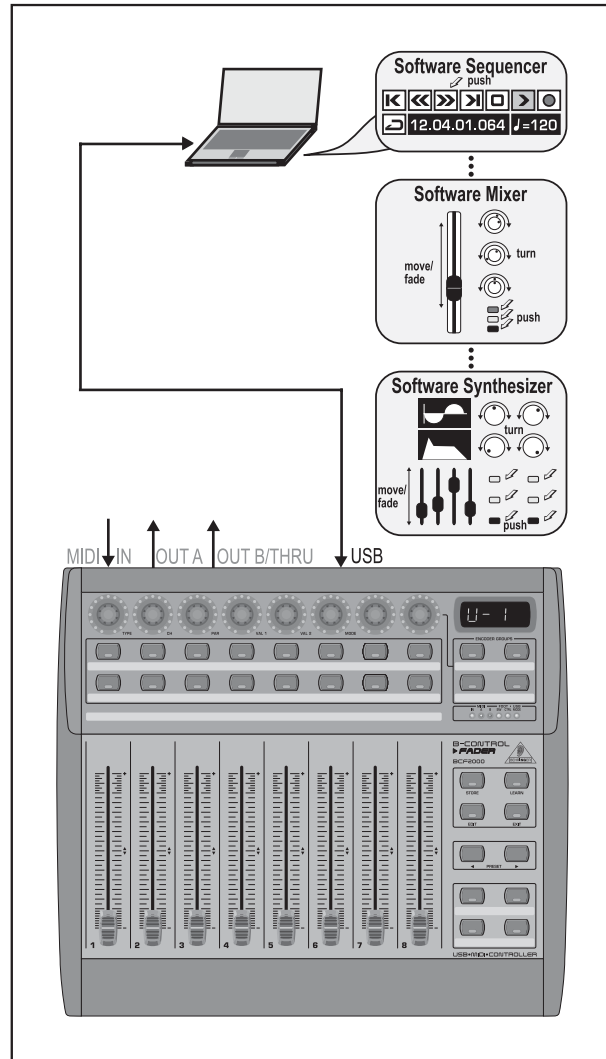

Fig. 4.1: Routing and use in USB mode 1

In USB mode 1, the B-CONTROL is connected to your PC by using a USB cable. It sends MIDI data and receives parameter feedback from the computer, provided that the music software you are controlling supports these functions. This way, current parameter values can be shown on the LED, or can be indicated by the fader position.

All MIDI ports of the B-CONTROL are off. This mode is optimal for controlling software tools (mixers, sequencers, synths, VST-effects etc.) if you don't need any additional MIDI ports. This mode is also very useful if you are already using other multi-channel MIDI interfaces on your computer and can't address any additional ones.



**USB-Mode U-2:**

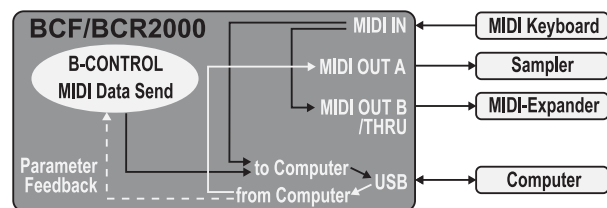
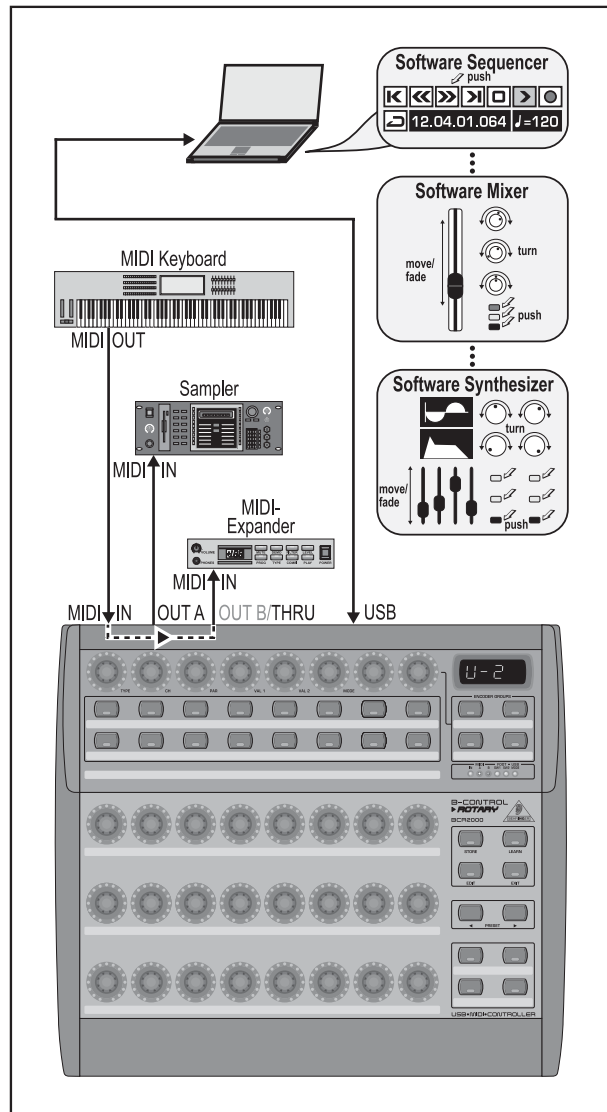

*Fig. 4.2: Routing and use in USB mode 2*

Your B-CONTROL sends MIDI data to the computer and receives parameter feedback, provided that the software you are controlling supports this function. MIDI IN and OUT A are available as a 16-channel MIDI interface for your computer. OUT B functions as MIDI THRU and forwards MIDI IN data unchanged. OUT B is not accessible from the computer, and doesn't send any control data from the B-CONTROL. This mode is ideal for applications in which you control music software on your computer and at the same time need a USB MIDI interface with one IN and one OUT. Additionally, a MIDI keyboard can be tapped into at the MIDI THRU (OUT B) connector. This way, you can use a master keyboard to import your arrangements into the sequencer, or to play back software synths. OUT A controls a hardware sampler, while a MIDI expander (sound generator without a keyboard; e.g. a rack synthesizer or a pure preset unit), an effects processor or similar can be connected at OUT B, whereby it is directly controlled only from the keyboard or is controlled only via program changes.

**USB-Mode U-3:**

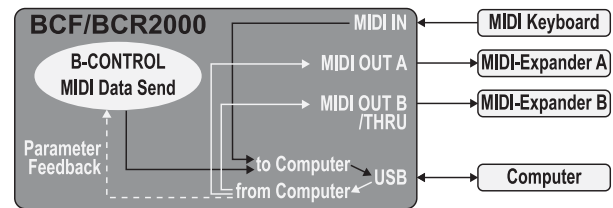
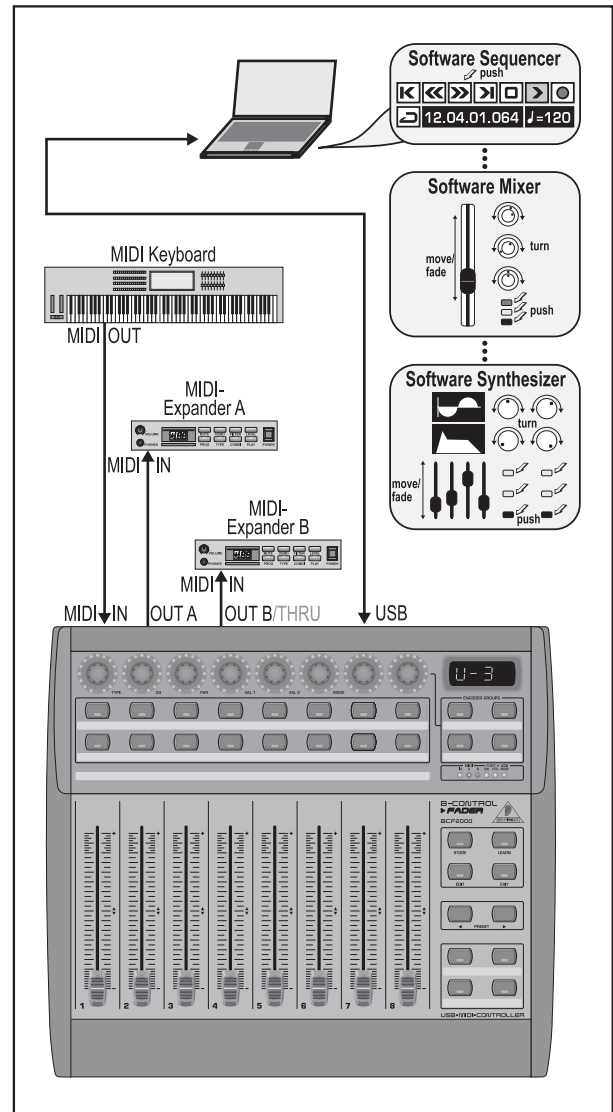

*Fig. 4.3: Routing and use in USB mode 3*

This is surely the most often used "standard mode" with computer applications.

This setting is optimal for controlling software while all MIDI connectors are used as a USB-MIDI interface for the computer. With this function, there are 16 input channels and 32 output channels available to your music software (IN and OUT A + OUT B).

The B-CONTROL transmits its data via USB to the computer. The availability of parameter feedback from the computer to the B-CONTROL depends on the software you are controlling. MIDI expanders can not be directly accessed from the keyboard in this operating mode. This operating mode is only used to import MIDI tracks into the sequencer.

USB-Mode U-4 (expanded):

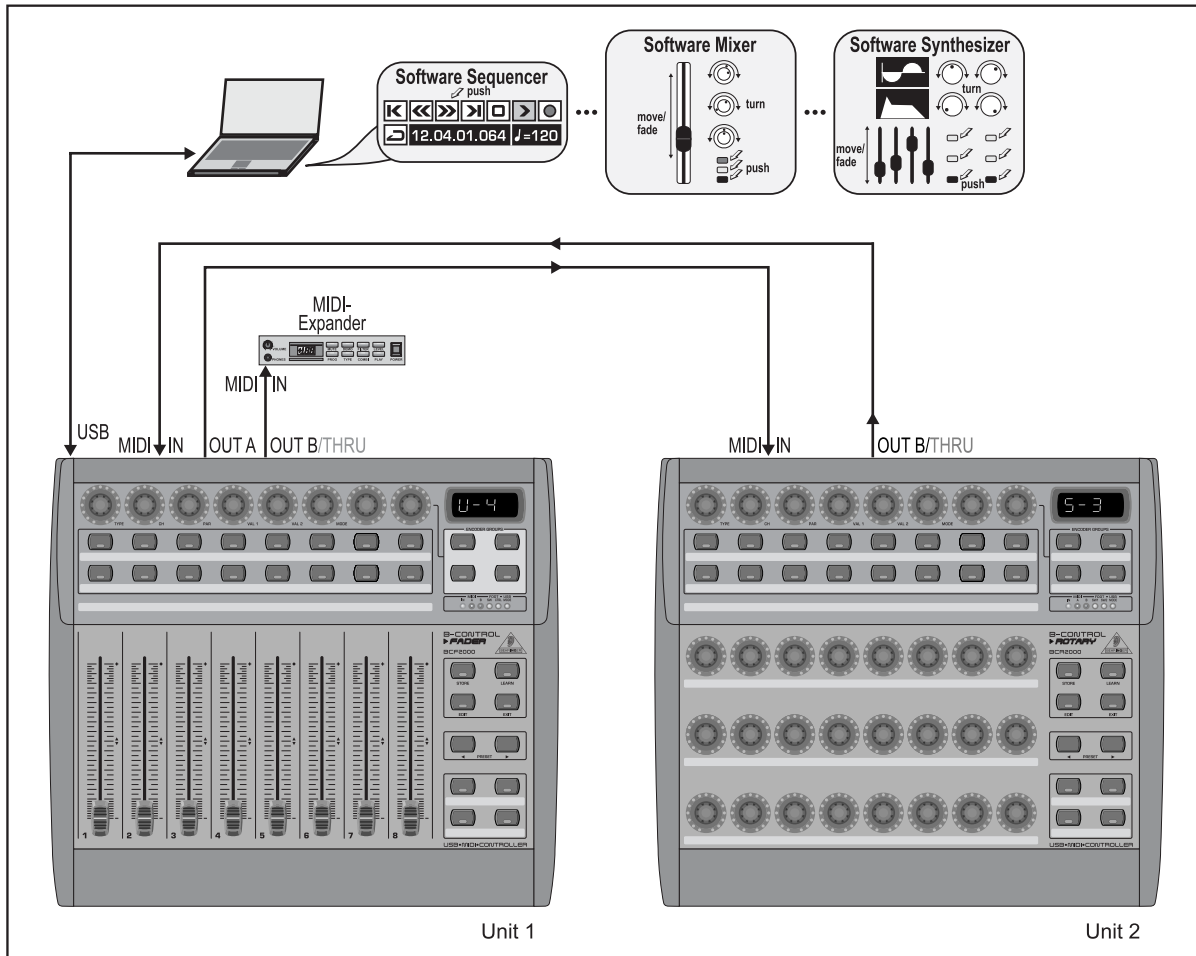

Fig. 4.4: Application in USB mode 4 (expanded)

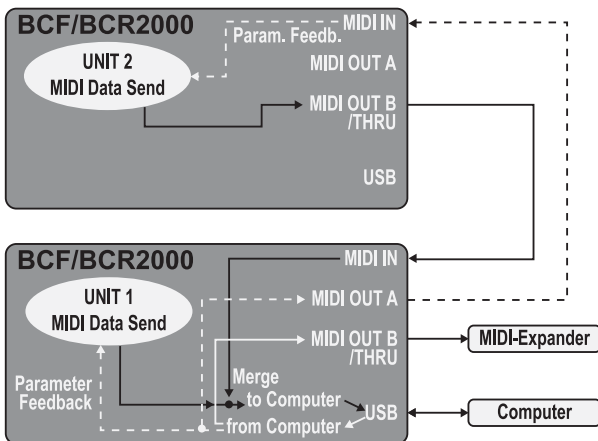

Fig. 4.5: Routing in USB mode 4

This operating mode should be selected if you want to couple two B-CONTROLS (e.g. 1x BCF2000 & 1x BCR2000) to control your software using both B-CONTROLS through a common USB port. Additionally, MIDI OUT B of the first controller (unit 1) can be used from the computer as a 16-channel MIDI output. The data of both B-CONTROLS is mixed and is sent to the host computer via USB. Select **stand-alone** mode 3 for the second unit (unit 2).

#### 4.1.2 Stand-alone modes

The stand-alone modes come into play when the B-CONTROL is not used as a USB-controller for controlling PC applications but as a pure MIDI controller. With all stand-alone modes, all MIDI connectors can be used simultaneously, and these modes differ only in how the data is transmitted on the MIDI outputs. Of course, not only sound generators can be remotely controlled (as shown in the illustrations) but also effects processors, groove boxes, hardware sequencers, lighting equipment, compact studios, portable keyboards, e-pianos etc. – basically any equipment with a MIDI input. This can also be your computer with its own MIDI interface. The USB connector can not be used while your B-CONTROL is in one of the stand-alone modes. A merge function that makes mixing MIDI data from two different sources to one output possible is active at output A in all stand-alone modes.

**Stand Alone-Mode S-1:**

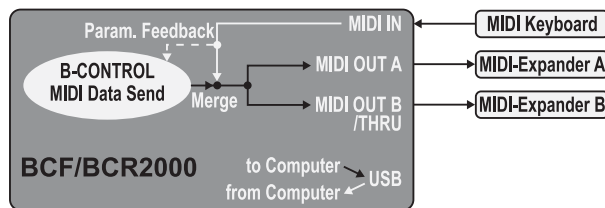
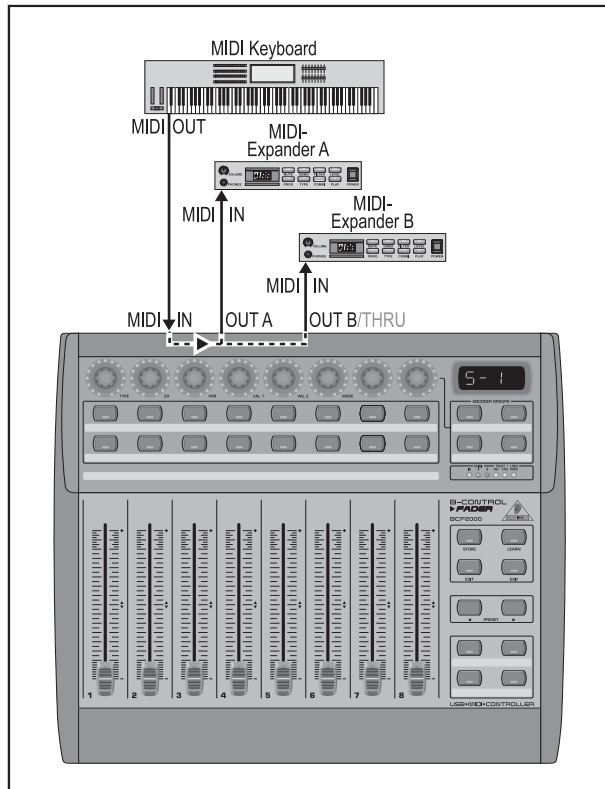

*Fig. 4.6: Routing and use in stand-alone mode 1*

S-1 is probably the most frequently used standard operating mode among the stand-alone applications. We recommend using it when you for example want to control two sound generators from your B-CONTROL, whereby both sound generators are played simultaneously from a master keyboard. To do this, MIDI data from the B-CONTROL and the keyboard have to be mixed and transmitted on both MIDI OUTs. This is done using the integrated merge function. The master keyboard is connected to the MIDI input of the B-CONTROL. Both expanders played from the master keyboard and controlled by the B-CONTROL are connected at the MIDI outputs. Control data for the BCF2000/BCR2000 will probably be program change and real-time controller commands, while the keyboard will typically transmit keyboard commands (note on/off, velocity, after touch, pitch bend).

**Stand Alone-Mode S-2:**

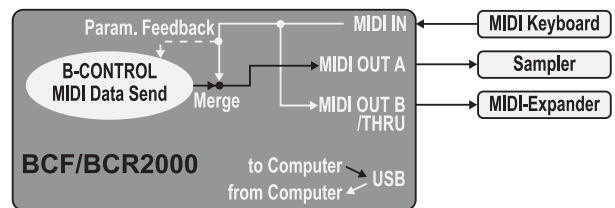
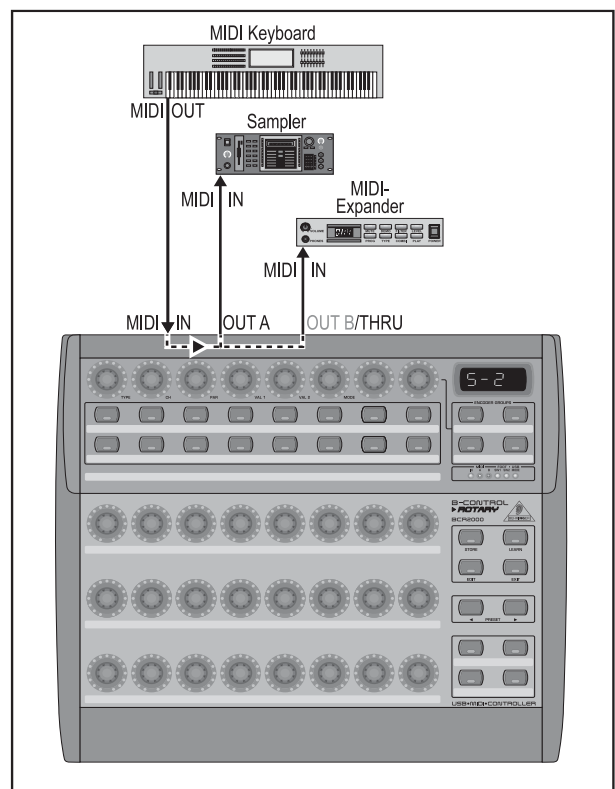

*Fig. 4.7: Routing and use in stand-alone mode 2*

Say you want to control just one sound generator from your B-CONTROL because the tone generator allows extensive editing (e.g. it's a rack synthesizer or a sampler, as shown above). The MIDI keyboard should be able to play both sound generators. In this case, S-2 is the optimal setup. The second sound module can be a pure preset unit that doesn't allow any programming. However, it can also be an effects unit that only receives program commands from the keyboard. This operating mode is also very useful when the data received by the second unit is undesired and could otherwise disrupt operation (e.g. to MIDI functions that cannot be switched off or the MIDI channel can not be changed).

**Stand Alone-Mode S-3:**

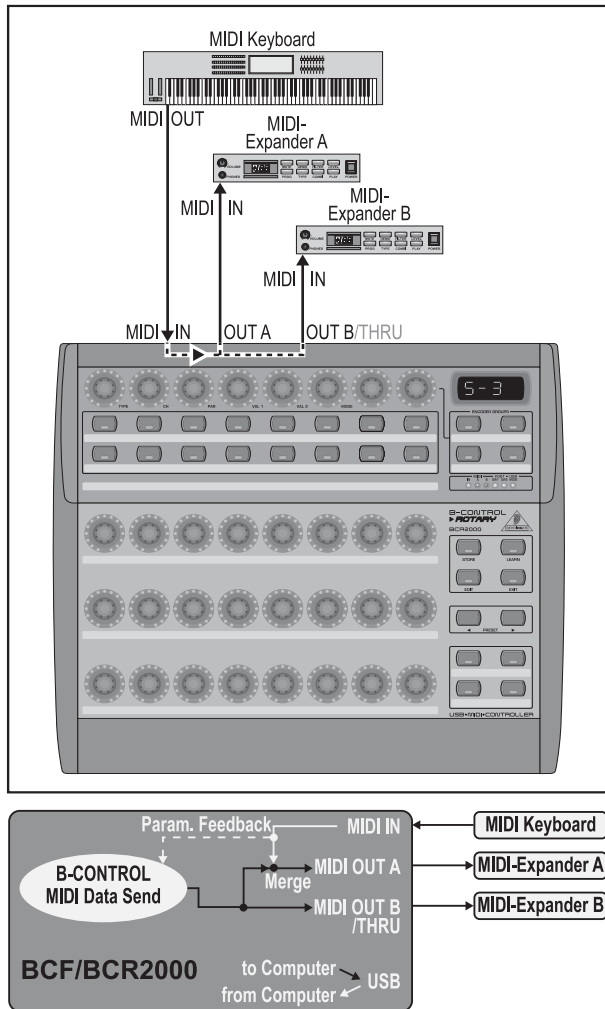

Fig. 4.8: Routing and use in stand-alone mode 3

In this mode, MIDI data from the BCF2000/BCR2000 is mixed with the data coming in at the MIDI input (merge function), but is exported exclusively on output A. Only control data of the B-CONTROL is available at output B.

This way, you can control two MIDI devices from your B-CONTROL, but only the device connected at OUT A can additionally be played from the MIDI keyboard.

**Important information about stand-alone modes:**

When connecting this way, parameter values of the controlled devices can be shown by the LEDs of your B-CONTROL. If parameter feedback is important, connect MIDI IN to MIDI OUT of the device you want to control. Of course, the hardware has to be capable of sending a response about the current parameter values. If you are not sure, check the equipment's user manual.

Parameter feedback in stand-alone mode 3 functions when MIDI output B is used. In all other stand-alone modes, undesired MIDI loops can occur; control data of the B-CONTROL are transmitted via MIDI OUT B only in stand-alone mode 3.

If you want to daisy-chain two B-CONTROLS to jointly control several MIDI devices, you need to connect OUT A of the first B-CONTROL to MIDI IN of the second B-CONTROL. OUT A of the second B-CONTROL needs to be connected to the MIDI input of the effects unit. If additional MIDI devices need to be "talked to," please connect the THRU port of one MIDI device to the IN port of the next MIDI device. This way, with different MIDI channel assignments, each MIDI device can be controlled from each one of the B-CONTROLS.

If additional MIDI inputs are needed, then external MIDI merge boxes must be used. For example, if your sound module only has one MIDI IN connector, and you want to control it from several MIDI controllers and from a keyboard, you will need a 2-in/1-out merge box.

If additional MIDI outputs are required, you will need external thru boxes. With more complex MIDI setups, thru boxes are preferred to using longer thru chains to prevent data transmission problems.

Your B-CONTROL can also control your computer via MIDI (without a USB connection) as long as your computer features a MIDI interface. In this case, all stand-alone modes can be used. When using parameter feedback, you must use stand-alone mode 3, and should connect your computer via MIDI IN and MIDI OUT B, so that no feedback loop occurs.

If you don't require the response function during software control, you can connect as many BCF2000/BCR2000s as you want per MIDI. The last B-CONTROL in the chain is then connected to the MIDI IN input of your computer. This way, you can control nearly as many channels of a software mixer as you wish. However, keep in mind that all devices must share 16 MIDI channels.

**4.2 "Play" mode menu**

The "Play" mode menu is the highest menu level in the B-CONTROL. Use it during normal operation for real-time control of MIDI data.

**Display:**

After switching on the unit, the current system software version is briefly displayed. Value changes are shown when using one of the control elements.

**Control elements:**

You can use several keys, encoders and faders simultaneously and send their MIDI data. The classification of MIDI data types is explained in chapter 4.3. According to its assigned MIDI data type, each control element shows the current parameter value in the corresponding LED or LED ring.

The position of the faders changes automatically as soon as you choose another preset or during incoming parameter messages.

**LED display:**

The **encoder** LED ring displays or the status LEDs of the **buttons** change automatically when running controller recordings in a sequencer, provided, of course, all connections have been made correctly, the correct operating mode is enabled and the software sequencer supports sending parameter values.

Button illumination varies according to the controller mode: if a **button** is in "Toggle on" mode, the button LED illuminates as soon as the button is pressed. Only when you press the button once again, the LED goes out. If a button is in "Toggle off" mode, the corresponding LED will be lit only for the time the button is pressed.

The LED rings of the **encoders** are normally displayed in a multi-step manner, i.e. turning the encoder from left to right lights the first LED followed by the next, whereby the first LED goes out etc. This way, even small value changes can be displayed accurately.

#### 4.2.1 Selecting a preset

- ▲ Select a preset with the PRESET button [8]. The new preset number is indicated in the display.
- ▲ Alternatively, you may select a preset by pressing and holding down the preset button while moving one of the push encoders [1].
- ▲ As soon as you release the PRESET button, the new preset is active.

#### 4.2.2 Copy/store presets

- ▲ Press the STORE button to save a preset. The button LED starts to flash.
- ▲ Select a memory number using the PRESET buttons or by holding down one of the PRESET buttons while moving a push encoder at the same time. The new preset number flashes in the display.
- ▲ By pressing STORE again, the STORE LED and the display stop flashing.
- ▲ If you want to overwrite the current preset, press the STORE button twice (step 2 can be cancelled).
- ▲ Cancel the store procedure by pressing the EXIT button.

We deliberately did not include an autostore function. That way, you can assign a new MIDI control to a control element without changing the current preset. If you want to restore a preset, just select another preset briefly and again return to editing. Now, the old data has been restored.

#### 4.2.3 Copying encoder groups

With this function you are able to copy an entire encoder group within a preset. This saves a lot of programming effort if all encoder groups within a preset consist of the same basic functions (e.g. MIDI channel, CC number for turn and push function).

- ▲ Press the encoder group button of the group you want to copy.
- ▲ Press STORE; the STORE button LED flashes.
- ▲ Now select the destination encoder group. The destination encoder button LED flashes.
- ▲ Press STORE again, the STORE button LED is no longer lit.
- ▲ Cancel the store procedure at any time by pressing EXIT.

 **To permanently store encoder group settings, carry out the preset store function as explained in chapter 4.2.2.**

 **To copy an encoder group into a *different* preset, you have to copy an entire preset! After that, you can copy or rearrange the encoder groups in the new preset as described above.**

### 4.3 Programming

#### 4.3.1 The LEARN function

The easiest way to assign MIDI functions to individual control elements is to use the LEARN function. Here, the MIDI data is assigned remotely. For example, MIDI data sent from a MIDI sequencer to your B-CONTROL is assigned to a control element selected beforehand.

With LEARN, not only CC, NRPN and note commands can be received but almost any type of MIDI data, including short SysEx strings.

- ▲ Press and hold the LEARN button while operating any control element. This can be a fader (BCF2000 only), an encoder (BCR2000 only), a PUSH encoder, button, footswitch or sustain pedal (BCF2000 only). The control element is shown in the display (e.g. E 24 or Fd 8).

 **When using push encoders, select an encoder group beforehand. In addition, you have to differentiate between turn and push function.**

- ▲ Now, release the LEARN button. The B-CONTROL is waiting to receive MIDI data.
- ▲ Start transmitting MIDI data from your sequencer. As soon as the data is received by the BCF2000/BCR2000, it is shown in the display.
- ▲ After correct data transmission, the display shows "GOOD" or "bAd" if wrong, faulty or too extensive data has been sent.
- ▲ To leave or cancel LEARN, press the EXIT button.

#### 4.3.2 Programming in EDIT mode

The detailed programming of all MIDI commands (e.g. pitch bend, After Touch, MMC, etc.) can be done in the EDIT mode.

- ▲ To activate the EDIT mode, press and hold the EDIT button and operate a control element. This can be a fader (BCF2000 only), an encoder (BCR2000 only), a push encoder, a button, footswitch or sustain pedal (BCF2000 only). The control element is indicated in the display (e.g. E 24 or Fd 8).

 **When using push encoders, select an encoder group beforehand. In addition, you have to differentiate between turn and push function.**

- ▲ Release EDIT; you are now in the EDIT mode.
- ▲ Using the push encoders 1 to 6, you can now assign MIDI commands to the selected control element. You will find all possible MIDI function in table 4.1, including all accompanying explanations.
- ▲ If you want to assign MIDI data to additional control elements, just press and hold the EDIT button and move one of the control elements. Now, let go of both controls and use the push encoders to assign a function to it (see table 4.1).
- ▲ To leave the EDIT mode, press EXIT.

 **Initially, all settings made here are stored temporarily! If you intend to store them in a preset, please see chapter 4.2.2.**

More detailed EDIT functions are described in the following table:



# B-CONTROL ► *FADER* BCF2000/B-CONTROL ► *ROTARY* BCR2000

Push-Encoder						
Controller Type	1	2	3	4	5	6
Controller Type	MIDI Data Type	MIDI Send Channel	Parameter	Value 1	Value 2	Controller MODE
Switch Type	<b>PROGRAM CHANGE</b>	1-16	Off, Bank Select MSB	Off, Bank Select LSB	Fixed Program Change-Value: Off, 0 - 127	-
Contin. Type		1-16	Off, Bank Select MSB	Off, Bank Select LSB	-	-
Switch Type	<b>CC</b>	1-16	CC 0-127	On-Value: 0-127	Off-Value: Off, 0-127	Toggle On/Off
Contin. Type		1-16	CC 0-127	Min. Value: 0-127/16383	Max. Value: 0-127/16383	Absolute Absolute (14-Bit) Relative 1 Relative 2 Relative 3 Relative 1 (14-Bit) Relative 2 (14-Bit) Relative 3 (14-Bit)
Switch Type	<b>NRPN</b>	1-16	NRPN Parameter-Number	On-Value: 0-127	Off-Value: Off, 0-127	Toggle On/Off
Contin. Type		1-16	NRPN Parameter-Number	Min. Value: 0-127/16383	Max. Value: 0-127/16383	Absolute Absolute (14-Bit) Relative 1 Relative 2 Relative 3 Relative 1 (14-Bit) Relative 2 (14-Bit) Relative 3 (14-Bit) Inc/Dec
Switch Type	<b>NOTE</b>	1-16	MIDI Note Number 0-127	Fixed Velocity-Value: 0-127	-	Toggle On/Off
Contin. Type		-	-	-	-	-
Switch Type	<b>PITCH BEND</b>	-	-	-	-	-
Contin. Type		1-16	-	Range 0-127	-	-
Switch Type	<b>AFTER TOUCH</b>	1-16	Key number 0-127, All (All = Channel Aftertouch)	On-Value: 0-127	Off-Value: Off, 0-127	Toggle On/Off
Contin. Type		1-16	Key number 0-127, All (All = Channel Aftertouch)	Min. Value: 0-127	Max. Value: 0-127	-
Switch Type	<b>MMC</b>	1-16	Select: Play, Pause, Stop, Fwd, Rew Locate Punch In Punch Out	Locate Position Time (1st Part): hh:mm Locate Position always sent first (before MMC-Command)	Locate Position Time (2nd Part): ss.ff (Frames) Locate Position always sent first (before MMC-Command)	Frame Rate: Off 24 25 30 30d
Contin. Type		-	-	-	-	-
Switch Type	<b>GS/XG</b>	1-16	Select GS/XG-Main Control-parameter with clear text indication	On-Value: 0-127	Off-Value: Off, 0-127	Toggle On/Off
Contin. Type		1-16	Select GS/XG-Main Control-parameter with clear text indication	Min. Value: 0-127	Max. Value: 0-127	-

Tab. 4.1: Assignment of the push encoders in EDIT mode

**Table explanation:**

All settings in the EDIT mode are made by turning the first six push encoders. Pressing the push encoder displays its current value. In addition, the setting options depend on whether the selected control element is a SWITCH type or CONTINUOUS type.

- ▲ SWITCH-type control elements are buttons, press functions for push encoders and footswitches.
- ▲ CONTINUOUS-type control elements include the eight BCF2000 faders, the 24 encoders of the BCR2000, the turn function of the push encoders and the sustain pedal (BCF2000 only).

In the EDIT mode, **Push Encoder 1** selects (by turning) the type of command assigned to a control element.

With **Push Encoder 2**, select a MIDI channel through which that control element's data is sent.

**Push Encoders 3 - 5** set parameters and values for the selected MIDI type. They vary depending on the MIDI function. More details about this subject can be found later in this chapter.

**Push Encoder 6** (Controller Mode) selects how the previously selected control element behaves, depending on whether it is a SWITCH or a CONTINUOUS type.

SWITCH-type control elements have two different modes: "Toggle On" and "Toggle Off." **Toggle On** is similar to a switching function (e.g. a light switch). Each time you press the switch, the value sent alternates between the "on" value (set by encoder 4) and the "off" value (set by encoder 5). This setting is perfect for triggering drum loops from a sampler (press once = start, press again = stop).

The **Toggle Off** mode corresponds to a momentary-contact button, comparable to the switch of an electric door opener. The "on" value is sent only as long as the button is pressed. After releasing the button, the "off" value is sent. Use this control type to trigger short sound FX or samples (similar to using a keyboard) by sending Note On and Offs.

CONTINUOUS-type element controls are divided into "Absolute," "Absolute (14 bit)," "Relative 1" (2nd complement), "Relative 2" (binary offset), "Relative 3" (MSB, most significant bit), "Relative 1 (14 bit)," "Relative 2 (14 bit)," "Relative 3 (14 bit)" and "Increment/Decrement." **Absolute** means absolute data values although jumps may occur when changing values. With **Relative**, the current parameter value is continued independently from the position of the control. **Absolute (14-Bit)** or one of the **Relative (14-Bit)** modes are standard modes for value changes at NRPNS with high resolution. This is necessary with some software mixers if more than 128 steps are needed. **Increment/Decrement** serves as a step-by-step increase or decrease of values by using the Data Increment/Decrement commands (see list 5.1 in the appendix).

 **The classic controller mode for most applications is "absolute". All other modes have to be supported by the MIDI software or the device to be controlled.**

**Program Change:**

With the encoders 3 and 4 you can select bank numbers. If a MIDI device contains more than 128 presets/programs, first a bank change command has to be sent. Even though this is a controller command, it has to be sent before the program change (and is therefore adjustable) since it is linked to the preset change. If the bank select message is not needed, simply select "off".

**Encoder 5** selects the program number. If the selected control element is a control dial (continuous type), the program number is directly selected when turning the dial. Pressing the switch directly selects the assigned program number. This can be useful if you always want to start from the same preset.

**Control Change CC:**

A control change consists of a controller number and its respective value. Encoder 3 sets the controller number. With buttons, different values can be sent when pressing and releasing (to be set with encoders 4 and 5). This function is useful if fixed parameter settings are to be sent.

With faders and control dials (continuous type), the value range can be determined by using encoders 4 (minimum value) and 5 (maximum value).

 **Alternatively, you can invert the value scale by assigning 127 as the minimum value and 0 as maximum value (scale inversion). A classic application is the draw bar control of virtual or digital organs or organ expanders. If assigning controller 7 (volume) to the faders of the BCF2000 this way, the signal becomes quieter when moving up the fader. Moving down the fader is similar to moving out the draw bars, and the volume increases.**

**NRPN:**

A NRPN is needed if none of the 127 standardized controller numbers are available for a certain function.

Encoder 3 selects the parameter number. For assigning mixer faders, we recommend the high resolution ("Absolute 14 bit"), provided that the control hardware/software supports it.

**Note:**

Of course, a note can only be assigned to one SWITCH element. The note is set with encoder 3. Note C3 (C key) corresponds with note number 60. Encoder 4 sets the note velocity (note volume).

**Pitch Bend:**

Pitch bend is assignable to only one CONTINUOUS element. Since this is a type of command with its own status byte, selecting a MIDI channel (Encoder 2) and Range (Encoder 4) is sufficient.

**After Touch:**

Normally, "ALL" is selected here. This means that **After Touch** affects all notes equally ("Channel Pressure"). If you want to use a polyphonic **After Touch** ("Key Pressure"), the single note on which **After Touch** should have an effect can be selected using encoder 3. Since this process is only supported by a few tone generators, channel After Touch will be best most of the time. When a switch element has been selected, an "on" and "off" value can also be set (release dynamic). Therefore, you can limit the modulation range (FX depth) using After Touch.

**MMC:**

MIDI Machine Control data is only assignable to button elements.

Encoder 4 (Value 1) sets "Locate Time" hour and minute values, while encoder 5 (Value 2) sets seconds and frames. The Locate Position is always sent before the MMC command. We therefore have the following logic-switching sequence:

If the "Locate" parameter has been selected, the sequencer or hard drive recorder always jumps to the set position. If "Play" has been selected as the parameter (for a button), the sequencer always starts from the set locator point as soon as the button is pressed. "Rewind" always begins at the chosen locator point. Select the frame rate with encoder 6: 24, 25, 30 (non-drop), 30d (drop frame) or "off" (in this case only the MMC message is sent, without any information of the locate position).

## GS/XG:

Encoder 3 directly selects the most important “Main Control” parameters. The display indicates them as a (shortened) text (table 4.2). In this case, these are CCs or NRPNs (no SysEx data).

GS/XG-Parameter	Typ	Display
Filter Cutoff	NRPN	CUTF
Filter Resonance	NRPN	RESO
Vibrato Rate	NRPN	RATE
Vibrato Depth	NRPN	DEPT
Vibrato Delay	NRPN	DLY
EG Attack	NRPN	ATC
EG Decay	NRPN	DCY
EG Release	NRPN	RELS
Modulation	CC 1	MODU
Portamento Time	CC 5	PORT
Volume	CC 7	VOL
Pan	CC 10	PAN
Reverb Send	CC 91	REVB
Chorus Send	CC 93	CRS
Delay/Variation Send	CC 94	VARS

Table 4.2: GS/XG Parameter Main Controls

Encoders 5 and 6 let you confine or invert each controllers’ value range.

### 4.3.3 Settings in the global setup menu

Settings that have an effect on all presets are made in the global setup menu.

- ▲ Keep the EDIT key pressed and at the same time press the STORE key.
- ▲ You are now in the global setup menu, and can let go of both keys.
- ▲ Now, turn the push encoders 1 to 6 to get the desired setting. This is how the push encoders are allocated:

Encoder	Function	Select
1	Operating Mode	U-1 ... U-4, S-1 ... S-3
2	Global RX Channel	Off, 1 ... 16
3	Footsw itch	Auto/Normal/Inverted
4	Start Preset	1 ... 32, Last
5	Device ID	1 ... 16
6	SysEx Dump	Single/All

Table 4.3: Push encoder allocation in global setup menu

#### Operating Mode:

The operating modes are described in chapter 4.1. You can select USB modes U-1 to U-4 and stand-alone modes S-1 to S-3.

#### Global RX Channel:

The B-CONTROL receives program change commands on this channel.

#### Footswitch type:

Because there are different kinds of footswitches (depending on their switching behavior), the polarity of the footswitch connector can be set (normal/inverted), or it can be automatically detected during power startup (auto recognition).

#### Start Preset Number:

Each of the 32 presets can be selected as the startup preset. Additionally, with the “Last” function, at startup you have the option to always load the preset that was used last.

#### Device ID Number:

You should change the ID number settings only if you work with several BCF2000s or BCR2000s at the same time, and problems with recognizing the correct device start occurring during a SysEx Dump procedure.

☞ Please keep in mind that SysEx Dumps can only be received at the device number to which they were sent!

#### SysEx Dump Select:

Turning push encoder 6 lets you select between the current preset (single) or the entire memory contents of the 32 presets (all) should be sent as a SysEx dump. One press on encoder 6 triggers the dump.

- ▲ To exit the global setup menu, press EXIT.

☞ The settings in the global setup menu take effect immediately and do not have to be separately stored.

### 4.3.4 Additional functions

#### Panic Reset:

This function resets the most important MIDI data to their factory settings.

- ▲ Press EDIT and keep it pressed.
- ▲ Now press EXIT. The reset is performed as soon as you press EXIT. “PANc” (for “Panic”) appears in the display.
- ▲ As soon as the reset is over, your B-CONTROL goes automatically into the play mode, and the current preset is shown in the display.

#### Data Request:

Current value settings of the MIDI device connected to your B-CONTROL can be transmitted to your B-CONTROL using the data request function (provided that the MIDI device supports this function, and a request command was defined using the editor software). In this case, the MIDI device doesn’t send data; the B-CONTROL requests them instead.

- ▲ Press the LEARN key while the EDIT key is kept pressed. The request takes place, and the B-CONTROL indicates the controller values of the receiving MIDI device on the LED ring or through fader positions.

#### Snapshot Send:

A Snapshot Send lets you send all current **controller values** in order to transmit the B-CONTROL settings to the connected MIDI device.

- ▲ Press the “◀ PRESET” key while the EDIT key is kept pressed. The B-CONTROL now sends the current controller settings.

#### Single Preset Dump:

In addition to the SysEx Dump function in the global setup menu, the following key combination lets you send **all settings of the current presets**:

- ▲ Press the “PRESET ►” key while the EDIT key is kept pressed.

☞ Snapshot Send and Single Preset Dump differ in the kind of data that is being sent: With Snapshot Send, only current control *values* are transmitted in order to synchronize them with the connected MIDI device. With Single Preset Dump, the entire contents of the current preset including the current control *assignments* are sent. With this function, you can easily archive certain presets, or swap them with other B-CONTROL users.

**5. APPENDIX**

Standard MIDI Controller (CC) Numbers							
00	Bank Select	32	Bank Select LSB	64	Damper Pedal (Sustain)	96	Data Entry +1 (Increment)
01	Modulation	33	Modulation LSB	65	Portamento On/Off	97	Data Entry -1 (Decrement)
02	Breath Controller	34	Breath Controller LSB	66	Sostenuto On/Off	98	NRPN LSB
03	Controller 3 (undefined)	35	Controller 35 (undefined)	67	Soft Pedal On/Off	99	NRPN MSB
04	Foot Controller	36	Foot Controller LSB	68	Legato Footswitch	100	RPN LSB
05	Portamento Time	37	Portamento Time LSB	69	Hold 2	101	RPN MSB
06	Data Entry MSB	38	Data Entry LSB	70	Sound Controller 1 (Sound Variation)	102	Controller 102 (undefined)
07	Channel Volume (formerly Main Volume)	39	Channel Volume LSB (formerly Main Volume)	71	Sound Controller 2 (Resonance/Timbre)	103	Controller 103 (undefined)
08	Balance	40	Balance LSB	72	Sound Controller 3 (Release Time)	104	Controller 104 (undefined)
09	Controller 9 (undefined)	41	Controller 41 (undefined)	73	Sound Controller 4 (Attack Time)	105	Controller 105 (undefined)
10	Pan	42	Pan LSB	74	Sound Controller 5 (Cutoff Frequency/Brightness)	106	Controller 106 (undefined)
11	Expression	43	Expression LSB	75	Sound Controller 6 (Decay Time)	107	Controller 107 (undefined)
12	Effect Control 1	44	Effect Control 1 LSB	76	Sound Controller 7 (Vibrato Rate)	108	Controller 108 (undefined)
13	Effect Control 2	45	Effect Control 2 LSB	77	Sound Controller 8 (Vibrato Depth)	109	Controller 109 (undefined)
14	Controller 14 (undefined)	46	Controller 46 (undefined)	78	Sound Controller 9 (Vibrato Delay)	110	Controller 110 (undefined)
15	Controller 15 (undefined)	47	Controller 47 (undefined)	79	Sound Controller 10 (undefined)	111	Controller 111 (undefined)
16	General Purpose 1	48	General Purpose 1 LSB	80	General Purpose 5	112	Controller 112 (undefined)
17	General Purpose 2	49	General Purpose 2 LSB	81	General Purpose 6	113	Controller 113 (undefined)
18	General Purpose 3	50	General Purpose 3 LSB	82	General Purpose 7	114	Controller 114 (undefined)
19	General Purpose 4	51	General Purpose 4 LSB	83	General Purpose 8	115	Controller 115 (undefined)
20	Controller 20 (undefined)	52	Controller 52 (undefined)	84	Portamento Control	116	Controller 116 (undefined)
21	Controller 21 (undefined)	53	Controller 53 (undefined)	85	Controller 85 (undefined)	117	Controller 117 (undefined)
22	Controller 22 (undefined)	54	Controller 54 (undefined)	86	Controller 86 (undefined)	118	Controller 118 (undefined)
23	Controller 23 (undefined)	55	Controller 55 (undefined)	87	Controller 87 (undefined)	119	Controller 119 (undefined)
24	Controller 24 (undefined)	56	Controller 56 (undefined)	88	Controller 88 (undefined)	120	All Sound Off
25	Controller 25 (undefined)	57	Controller 57 (undefined)	89	Controller 89 (undefined)	121	Reset All Controllers
26	Controller 26 (undefined)	58	Controller 58 (undefined)	90	Controller 90 (undefined)	122	Local Control On/Off
27	Controller 27 (undefined)	59	Controller 59 (undefined)	91	Effects 1 Depth (Reverb)	123	All Notes Off
28	Controller 28 (undefined)	60	Controller 60 (undefined)	92	Effects 2 Depth (Tremolo)	124	Omni Mode Off
29	Controller 29 (undefined)	61	Controller 61 (undefined)	93	Effects 3 Depth (Chorus)	125	Omni Mode On
30	Controller 30 (undefined)	62	Controller 62 (undefined)	94	Effects 4 Depth (Celeste/Detune)	126	Poly Mode Off/ Mono Mode On
31	Controller 31 (undefined)	63	Controller 63 (undefined)	95	Effects 5 Depth (Phaser)	127	Poly Mode On/ Mono Mode Off

Table 5.1: Standard MIDI Controller

GS/XG-Parameter	Typ	Display
Filter Cutoff	NRPN	CUTF
Filter Resonance	NRPN	RESO
Vibrato Rate	NRPN	RATE
Vibrato Depth	NRPN	DEPT
Vibrato Delay	NRPN	DLY
EG Attack	NRPN	ATC
EG Decay	NRPN	DCY
EG Release	NRPN	RELS
Modulation	CC 1	MODU
Portamento Time	CC 5	PORT
Volume	CC 7	VOL
Pan	CC 10	PAN
Reverb Send	CC 91	REVB
Chorus Send	CC 93	CRS
Delay/Variation Send	CC 94	VAR5

Table 5.2: GS/XG Parameter Main Controls

Musical Note	MIDI Note Number
C-2	0
C#-2/Db-2	1
D-2	2
D#-2/Eb-2	3
E-2	4
F-2	5
F#-2/Gb-2	6
G-2	7
G#-2/Ab-2	8
A-2	9
A#-2/Bb-2	10
H-2	11
C-1	12
C0	24
C1	36
C2	48
C3 (Clef C)	60 (Yamaha Convention)
C4	72
C5	84
C6	96
C7	108
C8	120
G8	127

Table 5.3: MIDI note number assignment

## 6. SPECIFICATIONS

### USB INTERFACE

Type Full-speed 12 MBit/sec.  
USB MIDI class-compliant

### MIDI INTERFACE

Type 5-pin DIN connectors IN, OUT A,  
OUT B/THRU

### CONTROL ELEMENTS

#### BCF2000

Controls 8 motorized 100-mm faders  
8 infinitely variable push encoders  
with LED rings  
Keys 20 keys  
10 system keys (4x Encoder Group,  
4x programming, 2x Preset)

#### BCR2000

Controls 24 infinitely variable encoders  
with LED rings  
8 infinitely variable push  
encoders with LED rings  
Keys 20 keys  
10 system keys (4x Encoder Group,  
4x programming, 2x Preset)

### DISPLAY

Type 4-digit 7-segment LED display

### SWITCHED INPUTS

#### BCF2000

Footswitch 1 x 1/4" TS connector  
with automatic polarity detection  
Foot pedal 1 x 1/4" TRS connector

#### BCR2000

Footswitch Input 1 1/4" TRS stereo connector for  
dual-footswitch  
Input 2: 1/4" TS connector  
both with automatic polarity  
detection

### POWER SUPPLY

Voltage 85 - 250 V~, 50 - 60 Hz  
Power consumption max. 10 W  
Fuse **T 1 A H**  
Mains connection Standard IEC receptacle

### DIMENSIONS/WEIGHT

Dimensions (H x W x D) 13" x 4" x 11 4/5"  
(330 mm x 100 mm x 300 mm)  
Weight  
BCR2000 approx. 2,15 kg (4 3/4 lbs.)  
BCF2000 approx. 2,60 kg (5 3/4 lbs.)

BEHRINGER is constantly striving to maintain the highest professional standards. As a result of these efforts, modifications may be made from time to time to existing products without prior notice. Specifications and appearance may differ from those listed or illustrated.



## 7. WARRANTY

### § 1 WARRANTY CARD/ONLINE REGISTRATION

To be protected by the extended warranty, the buyer must complete and return the enclosed warranty card within 14 days of the date of purchase to BEHRINGER Spezielle Studioteknik GmbH, in accordance with the conditions stipulated in § 3. Failure to return the card in due time (date as per postmark) will void any extended warranty claims. Based on the conditions herein, the buyer may also choose to use the online registration option via the Internet ([www.behringer.com](http://www.behringer.com) or [www.behringer.de](http://www.behringer.de)).

### § 2 WARRANTY

1. BEHRINGER (BEHRINGER Spezielle Studioteknik GmbH including all BEHRINGER subsidiaries listed on the enclosed page, except BEHRINGER Japan) warrants the mechanical and electronic components of this product to be free of defects in material and workmanship for a period of one (1) year\* from the original date of purchase, in accordance with the warranty regulations described below. If the product shows any defects within the specified warranty period that are not excluded from this warranty as described under § 4, BEHRINGER shall, at its discretion, either replace or repair the product using suitable new or reconditioned parts. In the case that other parts are used which constitute an improvement, BEHRINGER may, at its discretion, charge the customer for the additional cost of these parts.

2. If the warranty claim proves to be justified, the product will be returned to the user freight prepaid.

3. Warranty claims other than those indicated above are expressly excluded.

### § 3 RETURN AUTHORIZATION NUMBER

1. To obtain warranty service, the buyer (or his authorized dealer) must call BEHRINGER (see enclosed list) during normal business hours **BEFORE** returning the product. All inquiries must be accompanied by a description of the problem. BEHRINGER will then issue a return authorization number.

2. Subsequently, the product must be returned in its original shipping carton, together with the return authorization number to the address indicated by BEHRINGER.

3. Shipments without freight prepaid will not be accepted.

### § 4 WARRANTY REGULATIONS

1. Warranty services will be furnished only if the product is accompanied by a copy of the original retail dealer's invoice. Any product deemed eligible for repair or replacement under the terms of this warranty will be repaired or replaced.

2. If the product needs to be modified or adapted in order to comply with applicable technical or safety standards on a national or local level, in any country which is not the country for which the product was originally developed and manufactured, this modification/adaptation shall not be considered a defect in materials or workmanship. The warranty does not cover any such modification/adaptation, irrespective of whether it was carried out properly or not. Under the terms of this warranty, BEHRINGER shall not be held responsible for any cost resulting from such a modification/adaptation.

3. Free inspections and maintenance/repair work are expressly excluded from this warranty, in particular, if caused by improper handling of the product by the user. This also applies to defects caused by normal wear and tear, in particular, of faders, crossfaders, potentiometers, keys/buttons, tubes and similar parts.

4. Damages/defects caused by the following conditions are not covered by this warranty:

▲ improper handling, neglect or failure to operate the unit in compliance with the instructions given in BEHRINGER user or service manuals.

▲ connection or operation of the unit in any way that does not comply with the technical or safety regulations applicable in the country where the product is used.

▲ damages/defects caused by force majeure or any other condition that is beyond the control of BEHRINGER.

5. Any repair or opening of the unit carried out by unauthorized personnel (user included) will void the warranty.

6. If an inspection of the product by BEHRINGER shows that the defect in question is not covered by the warranty, the inspection costs are payable by the customer.

7. Products which do not meet the terms of this warranty will be repaired exclusively at the buyer's expense. BEHRINGER will inform the buyer of any such circumstance. If the buyer fails to submit a written repair order within 6 weeks after notification, BEHRINGER will return the unit C.O.D. with a separate invoice for freight and packing. Such costs will also be invoiced separately when the buyer has sent in a written repair order.

### § 5 WARRANTY TRANSFERABILITY

This warranty is extended exclusively to the original buyer (customer of retail dealer) and is not transferable to anyone who may subsequently purchase this product. No other person (retail dealer, etc.) shall be entitled to give any warranty promise on behalf of BEHRINGER.

### § 6 CLAIM FOR DAMAGES

Failure of BEHRINGER to provide proper warranty service shall not entitle the buyer to claim (consequential) damages. In no event shall the liability of BEHRINGER exceed the invoiced value of the product.

### § 7 OTHER WARRANTY RIGHTS AND NATIONAL LAW

1. This warranty does not exclude or limit the buyer's statutory rights provided by national law, in particular, any such rights against the seller that arise from a legally effective purchase contract.

2. The warranty regulations mentioned herein are applicable unless they constitute an infringement of national warranty law.

\* Customers in the European Union please contact BEHRINGER Germany Support for further details.

Technical specifications and appearance subject to change without notice. The information contained herein is correct at the time of printing. WINDOWS®, MAC OS X® as well as the names of companies, institutions or publications pictured or mentioned and their respective logos are registered trademarks of their respective owners. Their use neither constitutes a claim of the trademarks by BEHRINGER® nor affiliation of the trademark owners with BEHRINGER®. BEHRINGER® accepts no liability for any loss which may be suffered by any person who relies either wholly or in part upon any description, photograph or statement contained herein. Colors and specifications depicted may vary slightly from product. No part of this book may be reproduced or transmitted in any form or by any means, electronic or mechanical, including photocopying and recording of any kind, for any purpose, without the express written permission of BEHRINGER Spezielle Studioteknik GmbH. BEHRINGER® is a registered trademark.

ALL RIGHTS RESERVED.

© 2003 BEHRINGER Spezielle Studioteknik GmbH.

BEHRINGER Spezielle Studioteknik GmbH, Hanns-Martin-Schleyer-Str. 36-38,  
47877 Willich-Münchheide II, Germany  
Tel. +49 2154 9206 0, Fax +49 2154 9206 4903